

# Installation Manual

Sliding unit ST4/14 single sash with 1- and 2-fold track



## For your safety



- Ensure that no parts can fall on anyone below
- The insect screen is not suitable for fall protection
- Installation may only be carried out by qualified personnel.



## General Information











- No changes, attachments or conversions may be made to this product
- Check the parts to ensure that they are in good condition before mounting. Do not mount damaged parts









Please read these assembly instructions carefully, as we are not responsible for errors caused by incorrect installation!  
Use only stainless steel screws for mounting.

## Parts

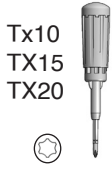
							
Corner joint bracket 11 48 36 2X	Allen Key 2.0mm 17 06 24.20 1x 2.5mm 17 06 25.25 1x	Stopper 2x 13 48 36	SK 2.9 x 9.5 15 04 29.09.TX 2x	RK 3,5x13 15 03 35.13.TX	Cap 14 23 91	Multi Plug 155006.35	SK 3.5 x 40 15 07 35.40.TX

## Recommended tools

					
Acrylic duct tape	Power drill	Tx10 TX15 TX20 Screwdriver and torx bits	HSS Aluminum drill ø 2.2 mm ø 2.9 mm ø 4.0 mm Countersink ø 9.8 mm Masonry Drill ø 6 mm	Hole puncher	Spirit level

## Vertical Section

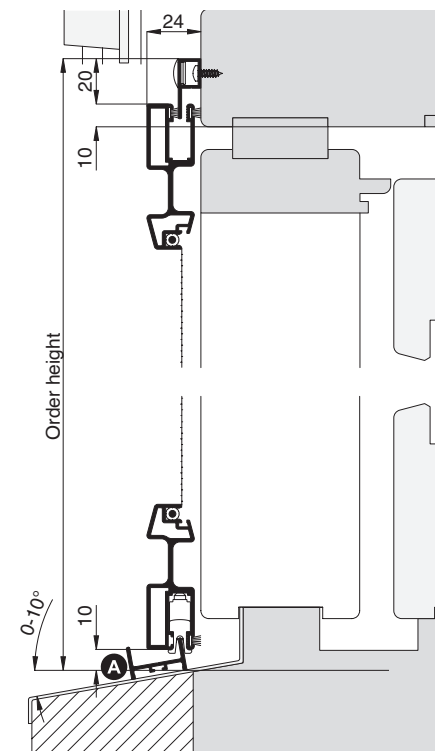

## Horizontal Section

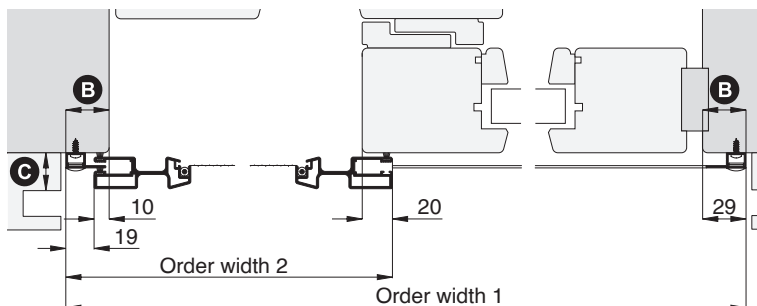

# Installation Manual

Sliding unit ST4/14 single-sash with 1- and 2-fold track

## 1 Slide rails assembly



Connect the upper and side track profiles with the corner joint bracket to form a U-frame. Alternately turn left and right set screws with the 2.0 mm Allen key to join the corners together until properly flush at the tip.

 **Mitres must not have a gap or misalignment**

 **Tighten set screws with a torque screwdriver to 1.5Nm**

## 2 Mount the track frame

① Screw stoppers with SK 2.9x9.5 on the upper running rail, before mounting the track frame

② Align the track frame and lower guide rail to the window frame and to each other

 **To fix the lower guide rail when aligning, use acrylic tape.**

③ Pre-drill through the mounting holes and screw on with RK 3.5x13.

 **Pre-drill wood windows with drill  $\varnothing$  2.2mm.  
Pre-drill aluminum windows with drill  $\varnothing$  2.9mm.**

Mark drilling positions through the mounting holes and drill with  $\varnothing$  6mm bit.

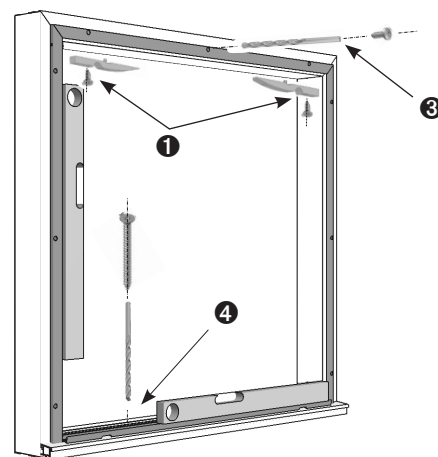

## 4 Schiebeflügel einhängen

Position the upper edge of the sliding sash on the upper runner so that the runner is moved into the sash guides. Push the sash up all the way ①. Swing in at the bottom ②, position on the lower running rail and release. ③

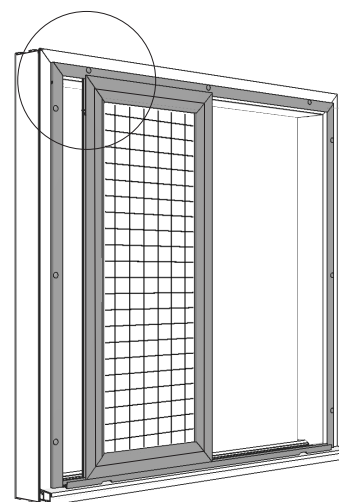
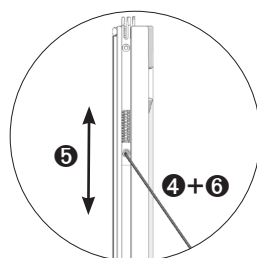
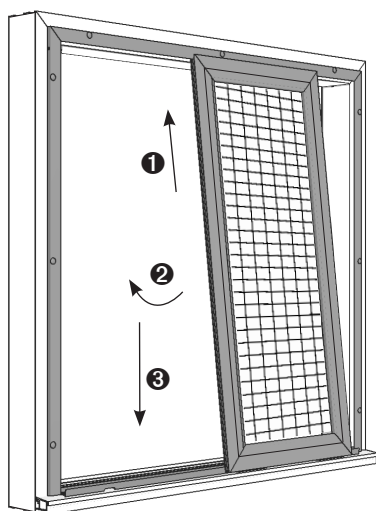

 The spring force of the sliding sash guide ⑤ can be adjusted if required: To do this, loosen screw with the provided Allen key ④, adjust spring force and tighten screw again ⑥.

On the opposite side of the handle, the sliding sash guide ⑥ can be pushed completely up (spring to block). This can be used as a safety catch and can reduce the jamming of smaller sashes. Attach cover caps.

# Installation Manual

Sliding unit ST4/14 single-sash with 1- and 2-fold track

⚠ Height-adjustable rollers can be readjusted to compensate for minor assembly inaccuracies.

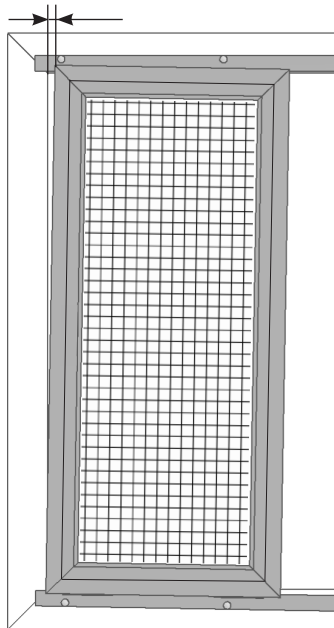

left (-) right (+)

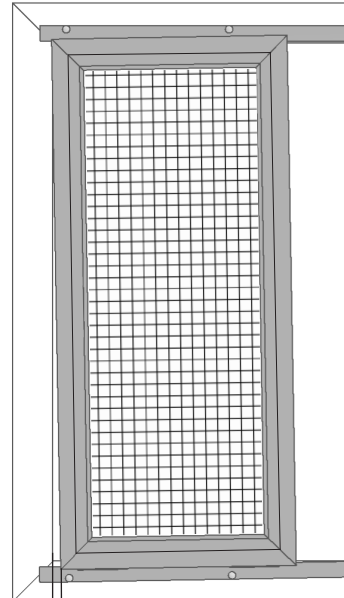

left (+) right (-)

By moving the plastic roll holder in the (-) direction the sliding sash on the side moves down by 1mm.

By moving the plastic roller holder in the (+) direction, the sliding sash on this side moves upwards by 1mm.

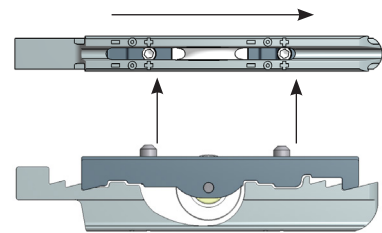
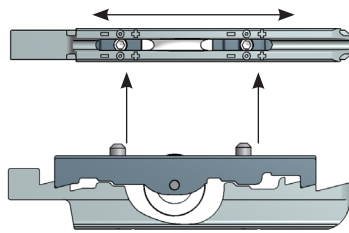
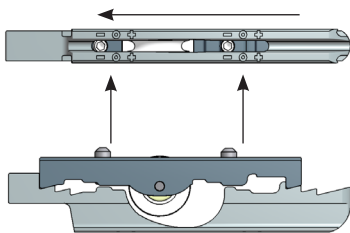

Maximum adjustment range 2mm (one side down, the other side up)! Since the width to height ratio is usually about 2:1, the top of the sliding sash can be swiveled by 4mm to the left or 4mm to the right.

Hold plastic guide part against the stop

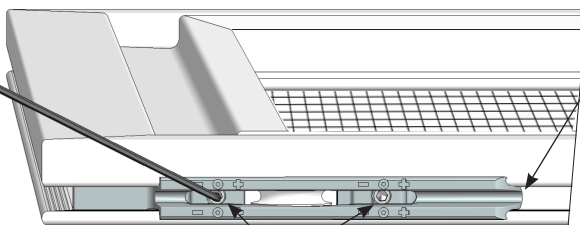

Loosen the screws with the Allen key 2.5mm and move the plastic roll holder in the desired direction. Then tighten the screws again.

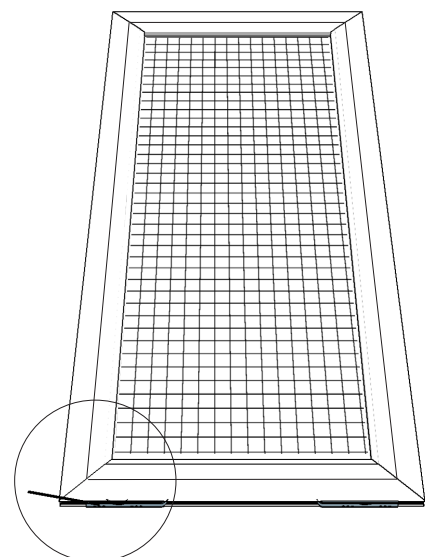

The location of the set screw with respect to "+" and "-" shows the current height position of the roller.