

Installation Manual

Hinged frame for door DT3/6 with mounting frame open at the bottom.

For your safety



- Ensure that the area below the door is not entered during assembly.
- When working under raised parts or work equipment, they must be secured with suitable devices against dropping.
- The insect screen is not suitable as an anti-fall device.
- With the "muted door" option, the magnets can influence the function of heart pacemakers and implanted defibrillator. If you carry a pacemaker keep a sufficient distance from the magnets. Required instructions are included in the manuals for these devices.
- The assembly may only be carried out by qualified personnel.

General information













- No additions or modifications may be made to the product.
- Check that the parts are in good condition before assembly. No damaged parts may be installed.



Please read this assembly manual carefully, as we can not be held liable for faults caused by incorrect installation.

Only use stainless steel screws for mounting.

Parts		Parts		Recommended tools					
									
Handle 10mm 13 35 52.xx.10	RK 3,5 x 9,5 15 03 35.09.TX	Cap 14 23 91	RK 3,5 x 13 15 03 35.13.TX	Lube spray	Power drill	Screw driver and torx bits TX10 TX15 TX20	HSS drill bit ø 4,5 mm ø 3,1 mm ø 2,5 mm	Counter-sinker 8 mm	Hole puncher

Horizontal section

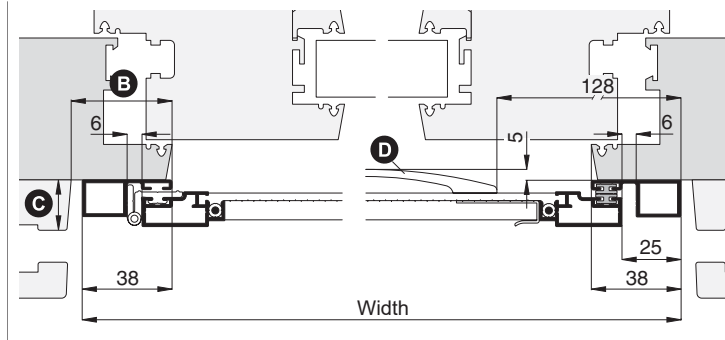

Vertical section

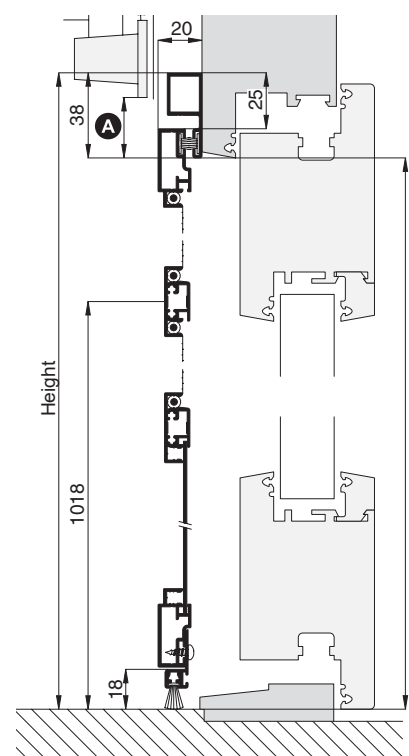

DT3/6 has brush pointing down

Installation Manual

Hinged frame for door DT3/6 with mounting frame open at the bottom.



LAROS
TECHNOLOGIES



1 Prepare the assembly

Determine the position of the mounting frame in front of the door frame.

Keep the mounting frame upright. Open and lift the sash to take it out. Pull out the hinge pins upwards.

Screw on the handle with screws RK 3.5 x 9.5 mm.

 **Do not damage the fabric during work!**

2 Mounting the frame

Align the frame horizontally and vertically on the door frame according to the specified dimensions and transfer the mounting holes.

Pre-drill accordingly.



In timber and plastic windows pre-drill with 2.5 mm drill bit. In aluminum windows pre-drill with drill Ø 3.1 mm.

Screw the mounting frame and cover the caps. Replace the insect protection frame and insert the hinge pins.



Spray hinge pins before assembly with lube spray to reduce wear and tear and to avoid squeaking noises in the future.

 **Ensure parallel alignment of the side mounting frame profiles! Match lengths of the diagonals!**

Use the brush seal to adjust the h profile to the bottom position. To do this, loosen the screws on the h profile slightly and close the rotating frame. Push profile down until the brush seal tightly closes, then tighten the screws again.

 **Check the safe hold of the insect screen**