

Installation Manual

Sliding Unit ST3/11, single sash with 1 fold track



LAROS
TECHNOLOGIES



For Your Safety



- Ensure that no parts can fall on anyone below.
- The insect screen is not suitable for fall protection.
- Installation may only be carried out by qualified personnel.









General Information





- No changes, attachments or conversions may be made to the product.
- Check the parts to ensure that they are in good condition before mounting. Do not mount damaged parts.



Please read these assembly instructions carefully, as we are not responsible for errors caused by incorrect installation! Use only stainless steel screws for mounting.

Parts				Recommended	
					
Screw Corner 11 48 36 4x	Allen Key 2,0mm 17 06 24.20 1x 2,5mm 17 06 25.25 1x	Sliding Sash Lock 2 x 13 48 36	SK 2,9 x 9,5 15 04 29.09.TX 2x	RK 3,5x13 15 03 35.13.TX	Cap 14 23 91

Recommended Tools	
	
Spirit Level	Power Drill
	
TX10 TX15 TX20 Screwdriver and torx bits	HSS Aluminum Drill ø 2,2 mm ø 2,9 mm ø 4,0 mm Countersink Bit ø 9,8 mm
	
	Hole Puncher

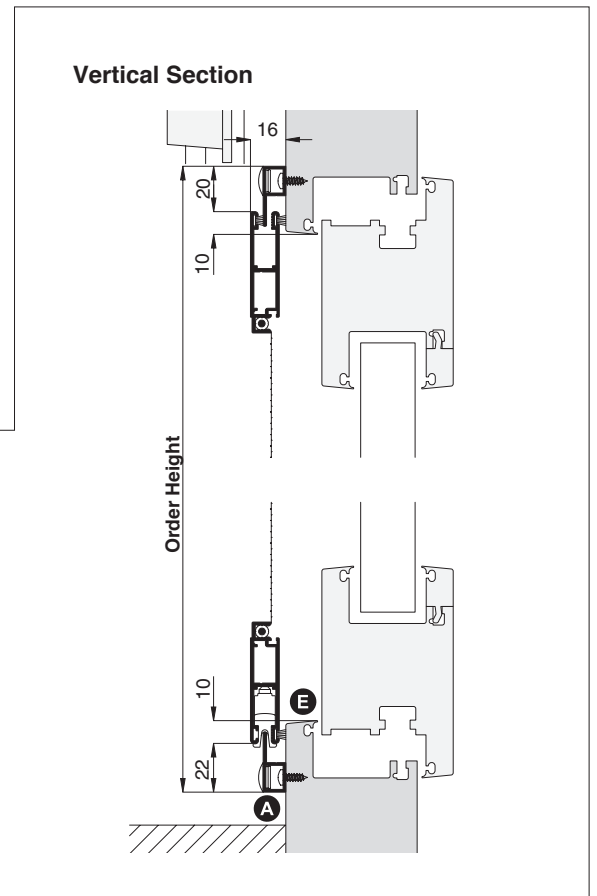
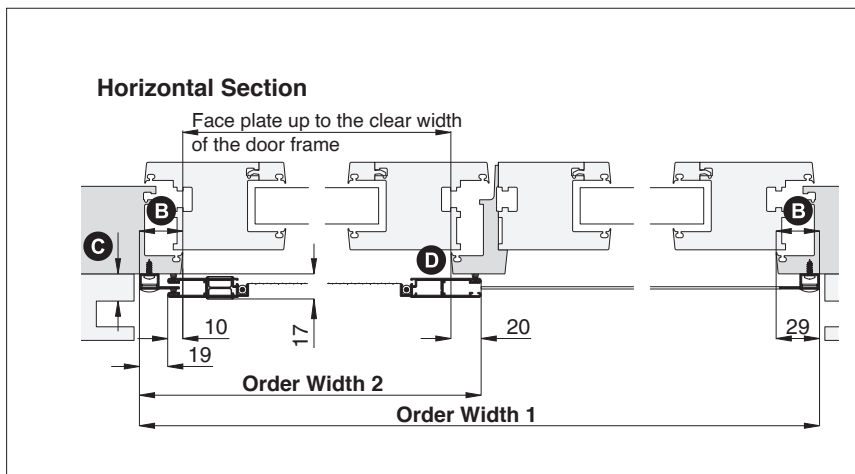

Installation Manual

Sliding Unit ST3/11, single sash with 1 fold track



LAROS
TECHNOLOGIES



1 Slide rails assembly



Connect the upper and side track profiles with the corner joint bracket to form a U-frame. Alternately turn left and right set screws with the 2.0 mm Allen key to join the corners together until properly flush at the tip.

⚠ **Mitres must not have a gap or misalignment.**

Tighten set screws with a torque screwdriver to 1.5 Nm

2 Mount the Track Frame

❶ Screw stoppers with SK 2.9x9.5 on the upper running rail, before mounting the track frame.

❷ Align the track frame and lower guide rail to the window frame and to each other.

👍 **To fix the lower guide rail when aligning, use acrylic tape.**

❸ Pre-drill through the mounting holes and screw on with RK 3,5x13.

👍 **Pre-drill wood windows with drill \varnothing 2.2 mm.
Pre-drill aluminum windows with drill \varnothing 2.9 mm.**

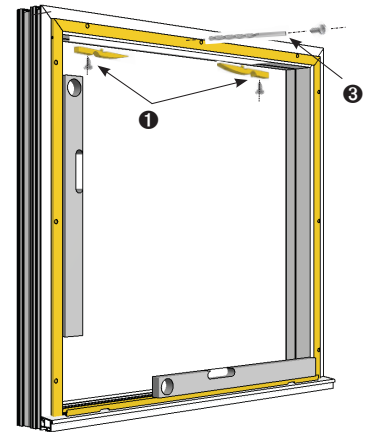

3 Suspend Sliding Sash

Position the upper edge of the sliding sash on the upper runner so that the runner is moved into the sash guides. Push sash up all the way ❶. Swing in at the bottom ❷, position on the lower running rail and release. ❸

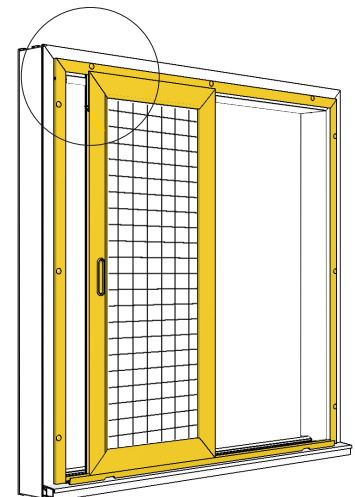
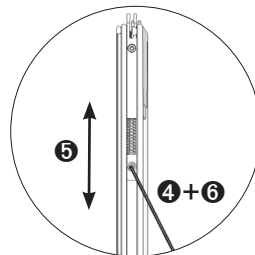
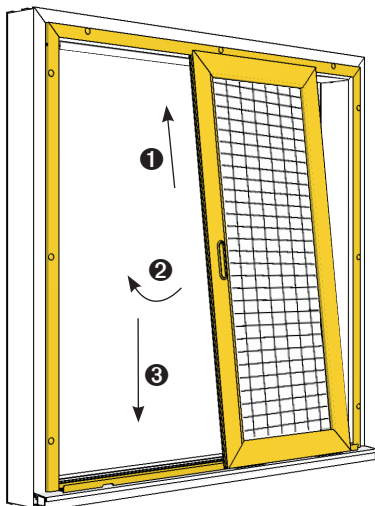

👍 The spring force of the sliding sash guide ❺ can be adjusted if required: To do this, loosen screw with the provided Allen key ❹, adjust spring force and tighten screw again ❻.

On the opposite side of the handle, the sliding sash guide ❺ can be pushed completely up (spring to block). This can be used as a safety catch and can reduce the jamming of smaller sashes. Attach cover caps.

Installation Manual

Sliding Unit ST3/11, single sash with 1 fold track



LAROS
TECHNOLOGIES



⚠ Height-adjustable rollers can be readjusted to compensate for minor assembly inaccuracies.

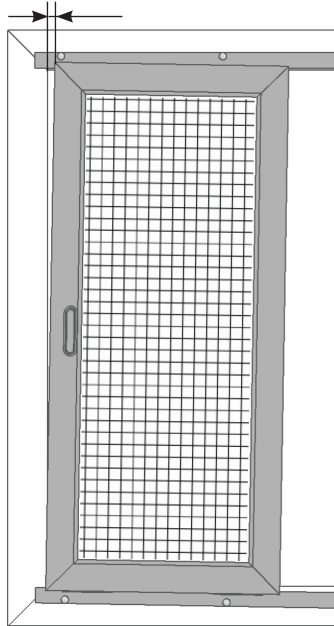

left (-) right (+)

By moving the plastic roll holder in the (-) direction, the sliding sash on this side moves down by 1 mm.

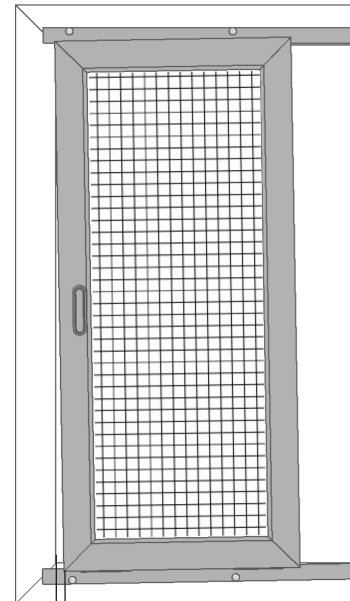
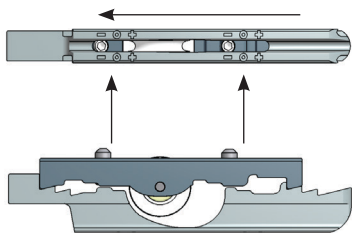

left (-) right (+)

By moving the plastic roll holder in the (+) direction, the sliding sash on this side moves upwards by 1 mm.

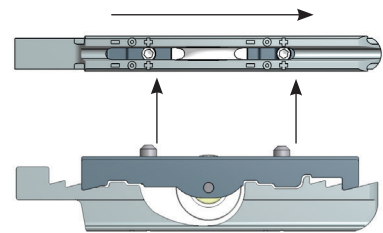
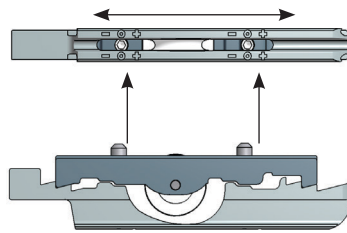

Maximum adjustment range 2 mm (one side down, the other side up)! Since the width to height is usually in the ratio 2: 1, the top of the sliding sash can be swiveled by 4 mm to the left or 4 mm to the right.

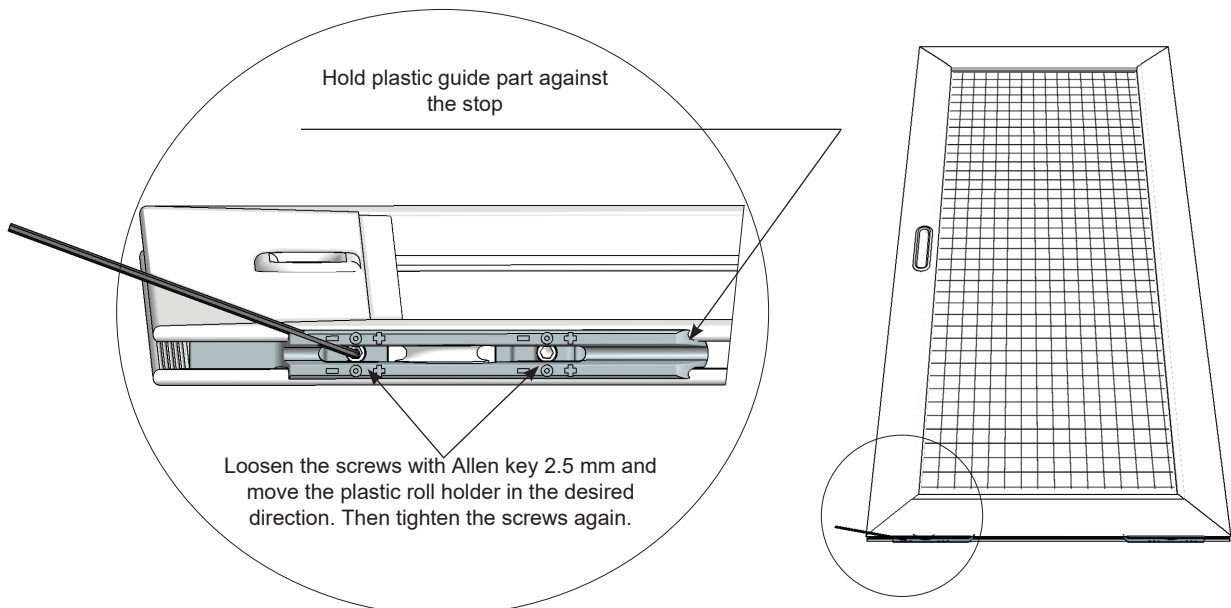

Hold plastic guide part against the stop

Loosen the screws with Allen key 2.5 mm and move the plastic roll holder in the desired direction. Then tighten the screws again.



The location of the set screw with respect to " + " and " - " shows the current height position of the roller.